



---

# iGp-1281F Signal Processor

---

## TECHNICAL USER MANUAL

*Author:*  
Dmitry TEYTELMAN

*Revision:*  
1.7

May 13, 2009



Information in this document is subject to change without notice.

Copyright © Dimtel, Inc., 2007. All rights reserved.

Dimtel, Inc.  
2059 Camden Avenue, Suite 136  
San Jose, CA 95124  
Phone: +1 650 862 8147  
Fax: +1 603 907 0210  
[www.dimtel.com](http://www.dimtel.com)



# Contents

<b>1</b>	<b>Regulatory Compliance Information</b>	<b>3</b>
<b>2</b>	<b>Introduction</b>	<b>4</b>
2.1	Delivery Checklist . . . . .	4
2.2	System Overview . . . . .	4
2.3	Front Panel Features . . . . .	6
2.4	Rear Panel Features . . . . .	8
2.5	Getting Started . . . . .	9
<b>3</b>	<b>IOC Setup</b>	<b>10</b>
<b>4</b>	<b>Utilities and Selftest</b>	<b>12</b>
4.1	Utilities . . . . .	12
4.2	Selftest . . . . .	13
<b>5</b>	<b>User Interface</b>	<b>16</b>
5.1	Installation . . . . .	16
5.2	Starting the EDM . . . . .	17
5.3	Bunch Pattern Specification . . . . .	17
5.4	Display Panels . . . . .	18
5.4.1	Main Panel . . . . .	18
5.4.2	Control Panel . . . . .	19
5.4.3	Coefficients Panel . . . . .	22
5.4.4	Coefficient Generator Panel . . . . .	24
5.4.5	Bunch Cleaning Panel . . . . .	25
5.4.6	Timing Panel . . . . .	26
5.4.7	Drive Panel . . . . .	28
5.4.8	Waveforms Panel . . . . .	30
5.4.9	Environmental Monitoring Panel . . . . .	32
5.4.10	Device Controls Panel . . . . .	33
5.4.11	8-channel ADC Panel . . . . .	34
5.4.12	GPIO Panels . . . . .	34
5.5	Power Amplifier Panel . . . . .	37
<b>6</b>	<b>External Software Interface</b>	<b>38</b>
<b>7</b>	<b>Specifications</b>	<b>39</b>



## CONTENTS

---

<b>8</b>	<b>Warranty and Support</b>	<b>43</b>
8.1	Warranty . . . . .	43
8.2	Support . . . . .	43
<b>9</b>	<b>Appendix A: Address Map</b>	<b>44</b>
9.1	Registers . . . . .	44
9.1.1	Overall Layout . . . . .	44
9.1.2	Gateway Config Register . . . . .	45
9.2	Drive pattern memory . . . . .	47
9.3	Environmental monitor . . . . .	48
9.4	MAX1202 8-channel ADC . . . . .	49
9.5	AD8842 8-channel DAC . . . . .	50
9.6	ECL delay lines . . . . .	51
9.7	General-purpose digital I/O . . . . .	51
9.8	Memory . . . . .	52
<b>10</b>	<b>Appendix B: Connector Pinouts</b>	<b>53</b>
<b>11</b>	<b>Glossary</b>	<b>58</b>



## 1 Regulatory Compliance Information

This equipment requires a ground connection provided by the power source. The exposed metal parts of the unit are connected to the power ground to protect against electrical shock. Always use an outlet with properly connected protective ground.

iGp-1281F was designed and tested to operate safely under the following environmental conditions:

- indoor use;
- altitude to 2000 meters;
- temperatures from 5 to 40 °C;
- maximum relative humidity 80% for temperature 31 °C, decreasing linearly to 50% @ 40 °C;
- pollution category II;
- overvoltage category II;
- mains supply variations of  $\pm 10\%$  of nominal.

iGp-1281F contains no user serviceable parts inside. Do not operate with the cover removed. Refer to qualified personnel for service.

**NOTE:** *This equipment has been tested and found to comply with the limits for a Class A digital device, pursuant to Part 15 of the FCC Rules. These limits are designed to provide reasonable protection against harmful interference when the equipment is operated in a commercial environment. This equipment generates, uses, and can radiate radio frequency energy and, if not installed and used in accordance with the instruction manual, may cause harmful interference to radio communications. Operation of this equipment in a residential area is likely to cause harmful interference in which case the user will be required to correct the interference at his own expense.*

**NOTE:** *This Class A digital apparatus complies with Canadian ICES-003. Cet appareil numérique de la classe A est conforme à la norme NMB-003 du Canada.*

## 2 Introduction

### 2.1 Delivery Checklist

1. iGp-1281F chassis;
2. AC power cord;
3. 16-pin ribbon cable;
4. 6 dB SMA attenuator;
5. 0.91 m SMA-to-SMA cable;
6. Compact disk with software and documentation;
7. User manual;
8. CE declaration of conformity.

### 2.2 System Overview

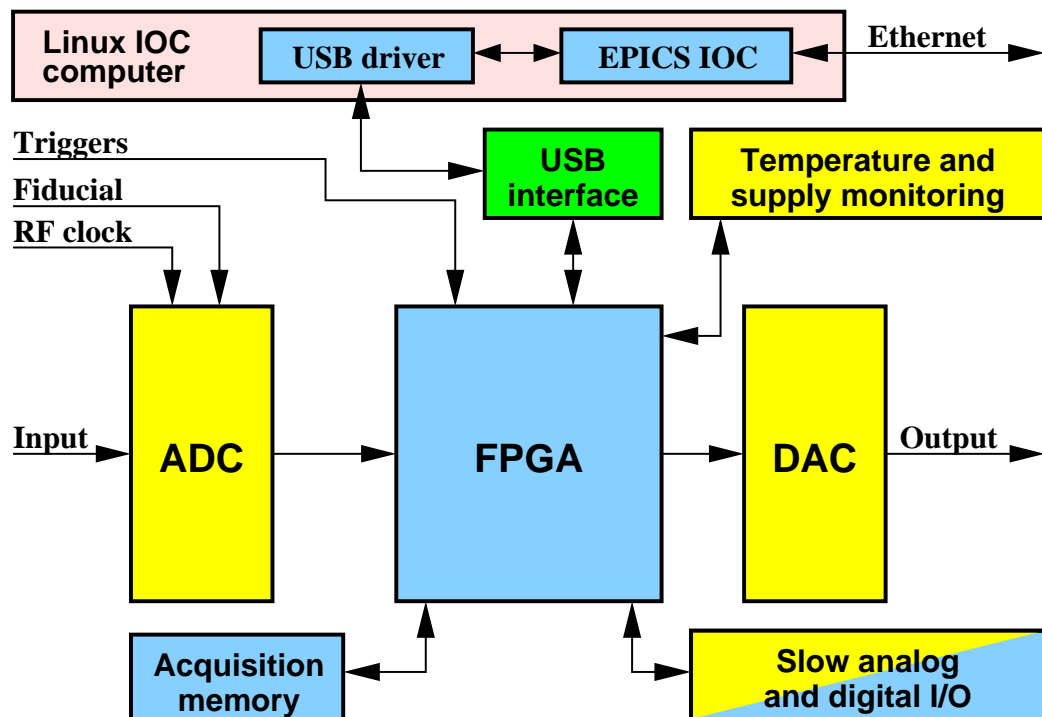

Figure 1: iGp-1281F block diagram

iGp-1281F signal processor is designed for the bunch-by-bunch feedback and diagnostics in lepton storage rings. Functionally iGp-1281F implements a baseband bunch-by-bunch processing channel configured for 1281 bunches. Each bunch is processed in a 16-tap finite impulse response (**FIR**) filter before being sent to the one-turn delay and, from there, to the high-speed digital-to-analog converter (**DAC**).

A block diagram of the iGp-1281F system is shown in Figure 1. The main signal processing chain consists of a high-speed analog-to-digital converter (**ADC**), a field programmable gate array (**FPGA**), and a high-speed **DAC** and is driven by the radio frequency (**RF**) clock. In addition to performing real-time control computations, the **FPGA** interfaces to a number of on-board devices, such as high-speed data acquisition memory (static random access memory (**SRAM**)), low-speed analog and digital input/output (**I/O**), as well as temperature and supply voltage monitors. In turn, the **FPGA** uses an internal universal serial bus (**USB**) connection to communicate to an embedded input-output controller (**IOC**) computer housed in the same chassis. The **IOC** runs the **Linux** operating system and is connected to the overall control system via the **Ethernet**.

## 2.3 Front Panel Features

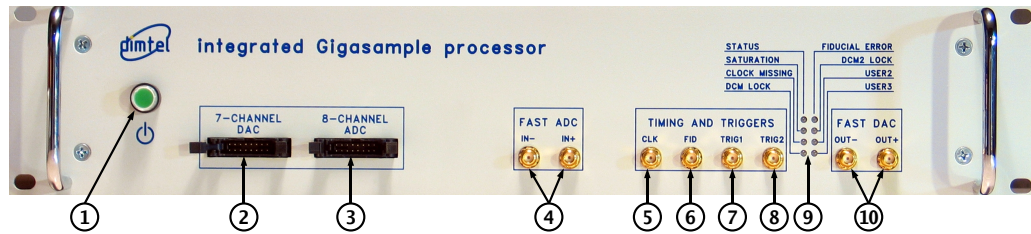

Figure 2: Front panel features

- 1) **Power switch** This momentary-on lighted switch turns iGp-1281F on and off. From the off condition, the unit will take 25–30 seconds to fully boot. Shutdown time after power switch actuation is 5–10 seconds.
- 2) **Low-speed DAC** This 16-pin connector provides 7 general-purpose analog outputs. **DAC** settings are adjustable via experimental physics and industrial control system (**EPICS**).
- 3) **Low-speed ADC** This 16-pin input connector is provided for measuring up to 8 external analog channels with 12-bit resolution.
- 4) **Fast ADC** Two SMA connectors accept the differential inputs for the high-speed **ADC**. When a single input is used the full-scale (**FS**) swing is 195 mV peak-to-peak. Differential mode swing is 97.5 mV peak-to-peak.
- 5) **RF Clock** This input accepts the high stability bunch crossing clock signal (**RF** clock). Nominal input level is -3 dBm. The signal is internally AC coupled.
- 6) **Fiducial** This input receives the revolution fiducial. Input is expected to be **NIM**-level. Active edge is the 0 to  $-0.8$  V transition. The signal must be stable within one **RF** period for reliable operation.
- 7) **Trigger 1** This input is currently unused.
- 8) **Trigger 2** This **NIM**-level input is used as an external trigger for data acquisition.
- 9) **LEDs** Eight front-panel LEDs provide indications of system activity and operating status.



**STATUS FPGA** Local bus activity is indicated in green.

**SATURATION FIR** filter operation status. Green indicates normal operation, red — output saturation.

**CLOCK MISSING** Red indication when the input **RF** clock is not detected.

**DCM LOCK** Lock status of the signal processing digital clock manager (**DCM**). Green — locked, red — unlocked.

**FIDUCIAL ERROR** Red indication if the fiducial is missing, at the wrong frequency, or jittering.

**DCM2 LOCK (USER1)** Lock status of the data acquisition **DCM**.

**USER2** Data acquisition activity indicated in green.

**USER3** Additional status of the signal processing **DCM**.

- 10) **Fast DAC** These two differential outputs are generated by the high-speed **DAC**. For proper operation both outputs must be terminated into 50  $\Omega$ .

## 2.4 Rear Panel Features

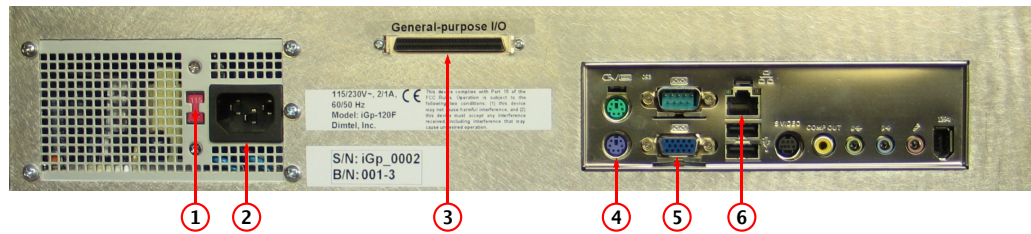

Figure 3: Rear panel features

- 1) **Voltage selection switch** Slide switch for selecting appropriate mains voltage: 115 or 230 V.
- 2) **Power entry socket** IEC-320 power input socket. Always use an outlet with properly connected protective ground.
- 3) **GPIO** This 68-pin connector provides 32 low-voltage transistor-transistor logic (**LVTTL**) signals for future expansion.
- 4) **PS/2 keyboard** Connect PS/2 keyboard for the initial setup of the iGp-1281F.
- 5) **Monitor output** Connect a monitor for the initial setup of the iGp-1281F.
- 6) **Network** This RJ-45 connector is used to connect the iGp-1281F to the control network. All control and data acquisition communications with the unit are performed via this network connection.

## 2.5 Getting Started

In this section we will present a quick step-by-step guide to get your new feedback processor running in a minimal configuration.

**WARNING: Before connecting power to the unit make sure the voltage selection switch (Fig. 3, item 1) is in the correct position (115 or 230 V).**

1. Configure voltage selection switch (Fig. 3, item 1). Mains supply requirements for the iGp-1281F are listed in Table 9;
2. Connect **RF** clock at  $-3$  dBm nominal level (Fig. 2, item 5);
3. Connect single-ended high-speed **ADC** input signal to **Ain+** (Fig. 2, item 4). The **FS** swing of this signal should be 190 mV peak-to-peak;
4. Connect a  $50\ \Omega$  terminator to **Ain-** (Fig. 2, item 4);
5. Connect high-speed **DAC** output(s) (Fig. 2, item 10) to the appropriate back-end unit;
6. If single-ended output configuration is used, connect a  $50\ \Omega$  terminator to the unused high-speed **DAC** output;
7. Connect a PS/2 keyboard (Fig. 3, item 4);
8. Connect a video monitor (Fig. 3, item 5);
9. Push the power button (Fig 2, item 1) to turn on the system;
10. Perform the **IOC** setup (see Chapter 3);
11. Push the power button (Fig 2, item 1) to turn the system off;
12. Disconnect the keyboard and the video monitor;
13. Connect the **Ethernet** (10/100BASE-T);

At this point your system is ready for internal testing and use in beam diagnostics and feedback. To extend the configuration beyond the minimum described above one can also connect the external fiducial and trigger signals (**NIM**-level).

### 3 IOC Setup

Setup program is included in the **IOC** for configuring the important features of the iGp-1281F. The program can be executed locally or remotely. For local execution one must first connect a keyboard (Fig. 3, item 4) and a video monitor (Fig. 3, item 5) to the system. For remote setup, use **ssh** after system bootup to establish connection. In both setup methods the user must login as **root** (initial password is supplied with the system). If the newly received iGp-1281F must be configured remotely (when, for example, a keyboard or a monitor is not available), such configuration can be performed using a dedicated network. Set up a network consisting of the iGp-1281F, a network hub or a switch, and a remote computer. The iGp-1281F is delivered with the following network configuration:

**IP address** 192.168.1.41  
**Netmask** 255.255.255.0  
**Gateway** 192.168.1.254

Configure the remote computer as follows:

**IP address** 192.168.1.254  
**Netmask** 255.255.255.0  
**Gateway** 192.168.1.41

Once the dedicated network is configured, remote connection to the iGp-1281F can be established by command **ssh root@192.168.1.41**. After logging in locally or remotely, start the setup program as follows:

```
[root@IOC ~]# setup
```

Setup program presents a series of text-mode window dialogs to collect the necessary information for configuring the iGp-1281F. The following settings are configured in this process: timezone, date, time, network, root password, and **EPICS** device name.

Setup dialogs are illustrated in Figure 4. Here we provide a step-by-step guide through the setup process.

- a) **Welcome panel** This panel provides a summary of settings handled by the setup program.

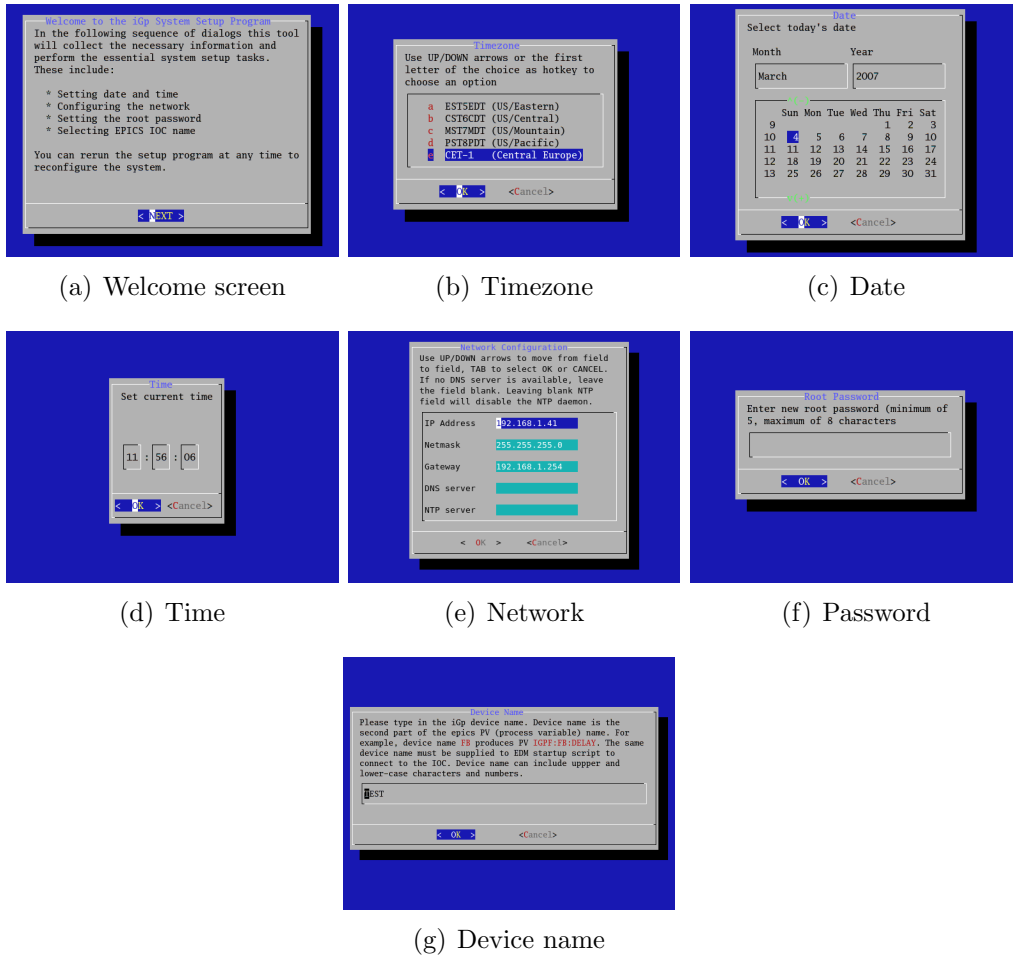

Figure 4: Setup screens

- b) **Timezone** In this panel, select the appropriate timezone.
- c) **Date** Set the correct date using the calendar.
- d) **Time** Set the correct time. The initial setting is taken from the current **IOC** time. If you know the current **IOC** time to be correct press **OK** quickly to retain the setting as closely as possible.
- e) **Network** Configure the **IOC** IP address, network mask and the default gateway as provided by your network administrator. The DNS and NTP server addresses are optional.



**NOTE:** *Only set the DNS address if the server connection is fast and reliable. Delays in DNS server access can negatively impact the operation of the **IOC**.*

- f) **Root password** Type in the new root password. The password must 5 to 8 characters in length. Please use the standard rules for selecting a strong password (Not based on a dictionary word, a mix of upper and lower-case characters and numbers).
- g) **Device name** This device name is the second part of the **EPICS** process variable (**PV**). All **PV** names start with **IGPF:X:**, where **X** is the device name. As delivered the iGp-1281F defaults to device name **TEST** producing **PVs** of the form **IGPF:TEST:DELAY**. If multiple iGp-1281F units are to be deployed they must be assigned differing device names. For example, one could use device names **X**, **Y**, **Z** for horizontal, vertical, and longitudinal feedback channels.

**NOTE:** *If the setup program is executed remotely and the network address is changed, the **ssh** connection will hang at the end of the process. To connect to the **IOC**, close the existing **ssh** session and start the new connection at the newly assigned **IOC** IP address.*

## 4 Utilities and Selftest

### 4.1 Utilities

The **IOC** includes several utilities designed to communicate to the iGp-1281F directly, without using the **EPICS** softIOC software. These utilities allow the user to access individual **FPGA** registers and memory locations. For register descriptions and address map see Sec. 9. All of the utilities below will accept addresses and data in decimal, hex, if preceded by **0x**, and octal, if the value starts from 0. For example, value 12 can be specified as 12, **0xc**, **014**. In order for these utilities to gain access to the **FPGA** interface the **IOC** process must be terminated. To terminate the **IOC** execute:

```
[root@IOC ~]# pkill st.cmd
```

Here is a short description of the available commands:

**usbr <addr>** Read a single register or memory location.

`usbw <addr> <val>` Write a single location.

`usbrblk <addr> <len>` Read a block of memory. The data is sent to `stdout` and can be redirected into a file.

`usbwblk <addr> <len>` Write a block of memory. This utility expects the data from `stdin`.

`usbttest <addr> <len> <cnt>` Test the register or memory block specified by the `addr,len` combination. The utility generates a block of random numbers and writes it to the **FPGA**. Then the data is read back and compared to the original values. Argument `cnt` specifies the number of test cycles to perform.

## 4.2 Selftest

Another important utility included in the **IOC** is `selftest`. This program performs testing of the main signal path, memories, and peripherals. In order to perform the testing system hardware must be configured as follows:

- Connect the 16-pin ribbon cable between the 7-channel **DAC** (Fig. 2, item 2) and the 8-channel **ADC** (Fig. 2, item 3);
- Connect 500 MHz clock to the **RF** clock input (Fig. 2, item 5);
- Terminate `Ain-` fast **ADC** input (Fig. 2, item 4);
- Terminate `Aout-` fast **DAC** output (Fig. 2, item 10);
- Connect 6 dB attenuator to `Aout+` fast **DAC** output;
- Connect the output of the attenuator to `Ain+` fast **ADC** input using the supplied SMA-SMA cable;
- Make sure no cable is connected to the general-purpose digital **I/O** port (Fig. 3, item 3);
- Make sure fiducial input is not driven (Fig. 2, item 6);

Once the hardware is configured the test procedure can be initiated by typing `selftest` at the **IOC** command prompt (establish local or remote connection to the **IOC** as described in Sec. 3). Example output of the test is shown below:



## 4.2 Selftest

```
1 Terminating the IOC
2
3 System information:
4   Function:          feedback
5   Harmonic number:  64
6   Demultiplexing:   4
7   Revision:          1.01
8   Serial number:    iGp-0003
9
10                STARTING THE AUTOMATED TEST SEQUENCE
11
12 Testing internal blockRAM: [OK]
13 Testing external SRAM: [OK]
14 Testing general-purpose digital inputs/outputs: [OK]
15 Verifying RF clock presence and DCM lock: [OK]
16
17 Testing low-speed DAC/ADC system
18 Ch(ADC) ADC(mV) DAC(mV) Off(mV) DAC(mV) ADC(mV)
19 1      -2040   -2062     5    2039   2025
20 2      -2024   -2039    -4    2039   2028
21 3      -2035   -2039    -3    2039   2033
22 4      -2029   -2039     2    2039   2035
23 5      -2025   -2039     8    2039   2030
24 6      -2033   -2039    -3    2039   2034
25 7      -2031   -2039    -3    2039   2035
26
27 Testing high-speed DAC offset channel
28 Offset DAC(cnt) Fast ADC(cnt)
29 -128             -17.3
30  66              1.0
31 127              6.9
32
33 Testing high-speed DAC output
34 HS DAC(cnt)      HS ADC(cnt)
35 -1574            -120.0
36  0               -0.0
37 1576             120.0
38
39 Environmental measurements
40 Bulk supply voltage (12V): 12.0
41 Vcc supply voltage (3.3V): 3.3
42 FPGA core supply voltage (1.5V): 1.5
43 iGp board temperature (deg C): 25.7
44 ADC temperature rise (deg C): 50.4
45 FPGA temperature rise (deg C): -0.3
```



46	FID clock delay temperature rise (deg C):	5.8
47	DAC clock delay temperature rise (deg C):	6.1

**Line 1** The utility terminates the **IOC** process to gain access to the **FPGA** interface.

**Lines 3–8** Contents of the **FPGA** config register are parsed and printed out.

**Line 12** Test of the data acquisition **blockRAM**.

**Line 13** External **SRAM** test.

**Line 14** General-purpose digital **I/O** is tested.

**Line 15** Presence of the RF clock is verified as well as the lock status of the **DCMs**.

**Lines 17–25** A test of the low-speed **DAC** and **ADC** system. This test uses 7 channels of the **DAC** to drive different voltages and measures the voltages using the **ADC**. The test measures several parameters for each channel. Test code finds the minimum **DAC** setting that does not saturate the **ADC**. **ADC** reading (column 2) and the dead-reckoned **DAC** output (column 3) are printed out in millivolts. Next the **DAC** is set to 0 and the **ADC** reading (offset, column 4) is taken. Finally, the code finds the maximum **DAC** setting that does not saturate the **ADC**.

**Lines 27–31** This portion of the test uses channel 7 of the slow **DAC** to adjust the output offset of the high-speed **DAC**. The code extracts the reading from the high-speed **ADC** at the positive and negative extremes of the offset **DAC**. Next the code finds the offset **DAC** setting that minimizes the high-speed **ADC** measurement. This setting should be very close to the factory determined value used in **EPICS** to null the high-speed **DAC** output.

**Lines 33–37** This fragment verifies the response via the high-speed **DAC**. To do so it finds the **DAC** settings to obtain readings of  $\pm 120$  and 0 counts from the **ADC**.

**Lines 39–47** Environmental monitor readings are taken and displayed.

The output of **selftest** utility can be redirected to a file and compared to the factory measurement provided in **/root/factory.selftest**.

After testing restart the **IOC** process by typing:

```
[root@IOC ~]# iGp_start
```



## 5 User Interface

User interface functionality for the iGp-1281F is implemented using extensible display manager (**EDM**). Software installation CD is designed for seamless installation on a client computer running one of the versions of Linux operating system listed in Table 1.

**Table 1: Supported Linux distributions**

Distribution	Versions
Red Hat Enterprise Linux	5
Scientific Linux	5.0, 5.1, 5.2
CentOS	5.0, 5.1, 5.2
Fedora	8, 9, 10

### 5.1 Installation

- Log into the client computer.
- Insert the installation CD into the CD-ROM drive.
- Mount the CD by accepting the "Open in New Window" option or by right clicking on the CD icon and selecting "Mount".
- Open a terminal window.
- Issue the following installation command:  
`sudo sh <CD mount point>/install.sh`. Typically CD mount point will be `/media/iGp`. *Note: to install the software one must have super-user privileges, obtained either via `sudo` or `su`.*
- When prompted, enter the user name to install under. If the specified user does not exist it will be created. Default user name is *iGp*.
- When prompted, enter the installation directory. Default directory is *iGp*.
- If the specified user did not exist, the program will prompt for password.
- Wait for the installation process to complete.

The resultant installation can support multiple **IOCs** with distinct device names. Refer to Section 3 for a definition of the device name. Each IOC must be added to the configuration. To do so, log in under the username,

specified during software installation (**EPICS** user). Open a terminal and type:

```
[iGp@host ~]$ IOC_add <IP address> <device name>
```

**WARNING: IOC and the client computer must be able to communicate at this point, otherwise IOC\_add will fail.**

After adding one or more new **IOCs** to the configuration the user must log out and log back in for the changes to take effect.

## 5.2 Starting the EDM

Once the software has been installed and the **IOCs** added via `IOC_add` you are ready to start the **EDM**. `iGp-1281F` display panels are opened by the following command:

```
[iGp@host ~]$ iGp_display [device name]
```

Note that the device name is optional. If the argument is omitted the command defaults to device name `TEST`.

## 5.3 Bunch Pattern Specification

Several fields in `iGp` interface (feedback, drive, bunch cleaning, and spectral averaging patterns) use common bunch pattern specification format. The syntactic structure of this format allows three types of elements: single bunch number, range, range with a step. Individual elements should be separated by spaces. Single bunch number element is an integer in the range from 1 to 1281. A range is specified as `start:stop`. Range can wrap around, that is if `stop` is smaller than `start`, the range covers `1:stop start:1281`. To specify a range with a step use `start:step:stop` construct. For example, drive pattern of `[2:2:1281 1:10 13]` includes all even bunches, range from 1 to 10, and bunch 13. If the first element of the pattern is `!`, the pattern is inverted, that is only listed elements are excluded. A pattern of `[!3 4]` includes all bunches except 3 and 4.

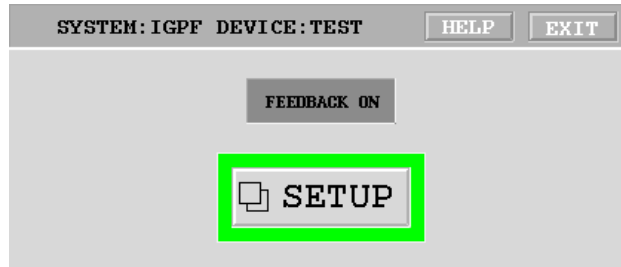

Figure 5: Main (top-level) panel

## 5.4 Display Panels

### 5.4.1 Main Panel

Running `iGp_display` brings up the top-level panel shown in Figure 5. All of the display panels include two buttons on the top: *HELP* and *EXIT*. *EXIT* button will always close the current window. In addition, *EXIT* button on the top-level panel will close the **EDM** session.

Top-level panel consists of three elements: *FEEDBACK ON/OFF* control, *SETUP* button and the status border around this button. The *FEEDBACK ON/OFF* control enables or disables the **FIR** filter output to the **DAC**. The status border indicates system operational status summary. **Green** indicates no errors, **yellow** - warning (saturation), **red** - error. The *SETUP* button opens the control panel shown in Fig. 6.

## 5.4.2 Control Panel

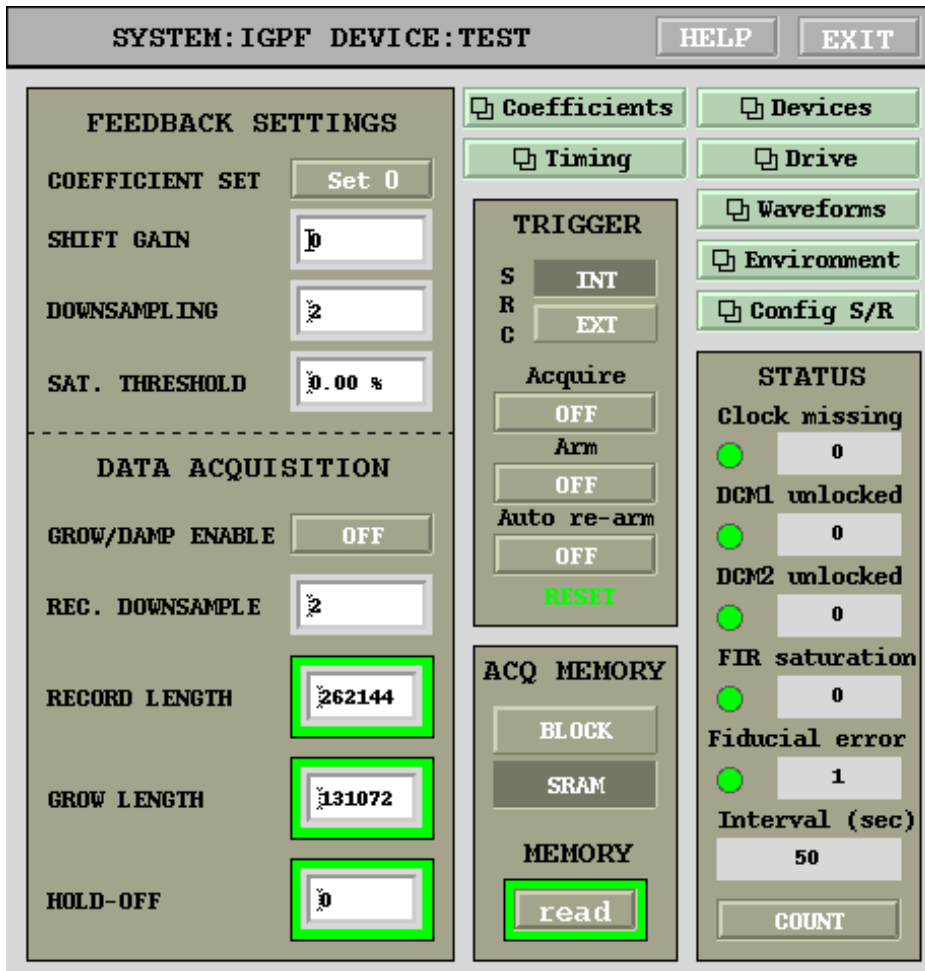

Figure 6: Control panel

This window integrates most important controls for the iGp-1281F.

**COEFFICIENT SET** Feedback coefficient set selector.

**SHIFT GAIN** Output gain adjustment, each step doubles the feedback gain.

**DOWNSAMPLING** Processing channel downsampling factor.

**SAT. THRESHOLD** iGp-1281F is equipped with an integrating saturation counter. The counter is compared with a threshold duty cycle, expressed here in percent. A setting of 50% indicates that the output was saturated half the time. On every poll cycle (once a second) the threshold comparison result is read out and the counter is reset to 0. Setting this field to a value of 0 produces single saturation event detector within a polling period,

**GROW/DAMP ENABLE** Enables coefficient set switching during data acquisition.

**REC. DOWNSAMPLE** Acquisition channel downsampling factor. This downsampling process is completely decoupled from the processing channel downsampling.

**RECORD LENGTH** Number of samples to acquire during data acquisition. The value is limited to 131072 for **blockRAM** and 8388608 for **SRAM**. Lengths up to 524288 will be read out every second. Longer acquisition lengths will require multiple poll periods to read out.

**GROW LENGTH** Number of samples to hold the coefficient set select inverted during data acquisition.

**HOLD-OFF** Number of groups of 4 samples to keep the coefficient set select inverted before data acquisition. This can be used to delay data acquisition and give slow oscillations time to grow.

**TRIGGER SRC** Acquisition trigger source, internal or external. External trigger is taken from TRIG2 input (**NIM**-level).

**Acquire** Acquisition trigger pushbutton for internal trigger. This control is no longer actively used - see the waveform panel (Fig. 12).

**Arm** External trigger is only valid if the acquisition system is armed. Single-event acquisitions on the external trigger can be performed by pushing this button.

**Auto re-arm** This option re-arms the acquisition system after each data readout. This allows for continuous updates of beam data triggered by external signal.

**ACQ MEMORY** Selects which memory, **FPGA blockRAM** or **SRAM** is used for acquisition.

**MEMORY read** Reads out the results of the last acquisition and places them in a file on the **IOC**.

**Coefficients** Opens **FIR** coefficients control panel.

**Timing** Opens timing control panel.

**Devices** Opens the control panel for the integrated devices.

**Drive** Opens the drive control panel.

**Waveforms** Opens the data acquisition and display panel.

**Environment** Opens the environmental monitoring panel.

**Config S/R** Configuration save/restore panel.

**Clock missing RF** clock missing indicator.

**DCM1 unlocked** Signal processing **DCM** lock indicator.

**DCM2 unlocked** Data acquisition **DCM** lock indicator.

**FIR saturation** **FIR** filter output saturation duty cycle exceeds the threshold level.

**Fiducial error** Indicates missing or jittering fiducial.

**Interval** Number of polling cycles (seconds) since the last error counter reset.

**COUNT** Reset error and interval counters.

## 5.4.3 Coefficients Panel

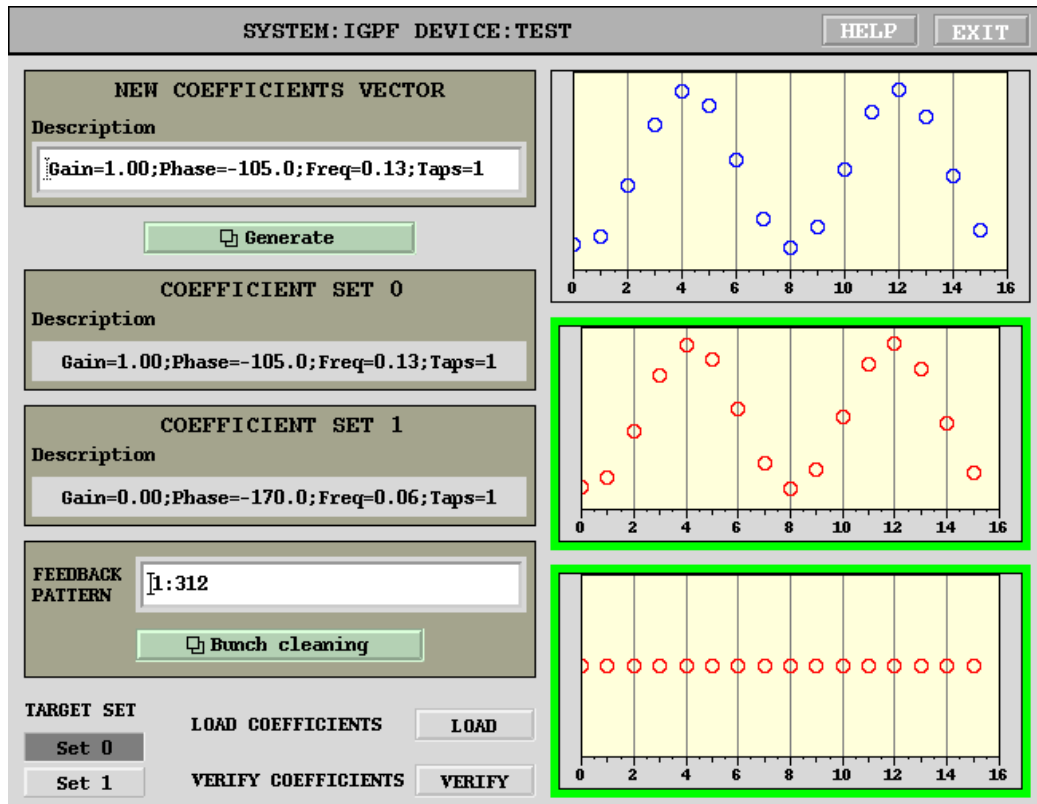

Figure 7: Coefficients panel

Coefficients control panel allows the user to manipulate the loaded coefficients sets and verify that the hardware is in sync with the panel display. The panel is split into three functional groups: new coefficients vector, coefficient set 0, and coefficient set 1. The first group shows the coefficient vector and its description generated using coefficient generator panel (Fig. 8). This vector can be loaded into hardware coefficient sets 0 or 1. Colored borders around the hardware coefficient displays indicate the results of coefficient verification. Green shows that the readback is in agreement with the EPICS values.

**Generate** Opens the coefficient generator panel.



**FEEDBACK PATTERN** This field enables the feedback output for the specified bunch pattern. Bunch specification format is described in Section 5.3.

**Bunch cleaning** This button opens the bunch cleaning panel.

**TARGET SET** Selects which set the new coefficient vector is to be loaded.

**LOAD COEFFICIENTS** Loads the new vector to the hardware coefficient set specified by *TARGET SET*.

**VERIFY** Verifies coefficient sets 0 and 1 against hardware values.

## 5.4.4 Coefficient Generator Panel

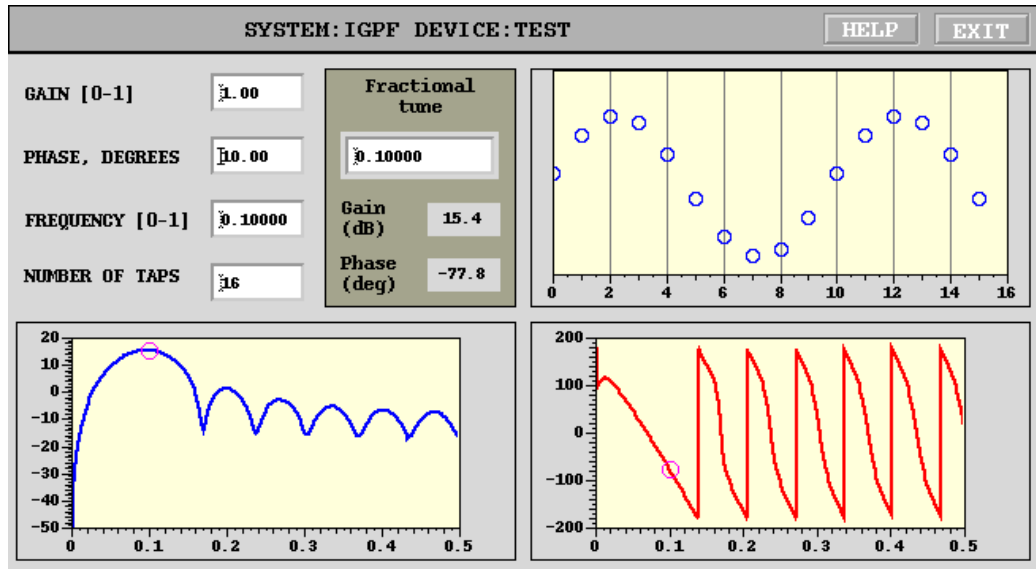

Figure 8: Coefficient generator panel

Coefficient generator panel shown in Figure 8 allows the user to generate feedback processing controllers and explore different delay/gain/bandwidth tradeoffs. This tool generates a coefficient set based on sampling a sine wave. Transfer function of the filter is computed and displayed together with an adjustable marker.

**GAIN** Filter gain in the range from 0 to 1.

**PHASE** Filter phase in degrees.

**FREQUENCY** Center frequency in fractional tune units. Multiply this by the revolution frequency to get the physical center frequency.

**NUMBER OF TAPS** Number of filter taps.

**Fractional tune** Marker frequency.

**Gain (dB)** Gain at the marker frequency in dB.

**Phase (deg)** Phase at the marker frequency in degrees.

## 5.4.5 Bunch Cleaning Panel

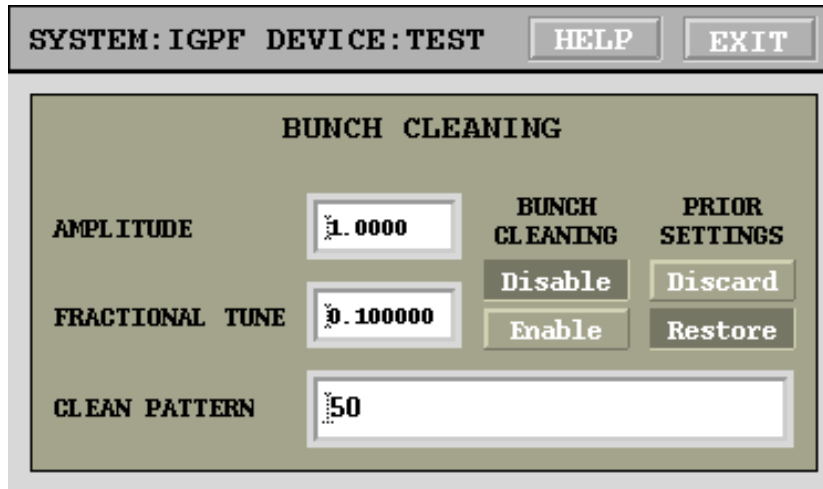

Figure 9: Bunch cleaning panel

Bunch cleaning panel shown in Figure 9 provides a single-point interface to configure both feedback and bunch cleaning controls. When bunch cleaning is enabled, drive pattern is loaded with the cleaning pattern. Simultaneously the feedback pattern is set to the complement of the drive pattern, that is each bunch is either driven (cleaned) or controlled by feedback. Drive amplitude and frequency are set to the values defined in the cleaning panel. Drive signal is set to a sinewave.

**AMPLITUDE** Cleaning signal amplitude, 0 to 1.

**FRACTIONAL TUNE** Fractional tune, 0 to 1.

**CLEAN PATTERN** Bunch pattern to clean - all other bunches are set to feedback.

**BUNCH CLEANING** Cleaning enable control.

**PRIOR SETTINGS** When bunch cleaning is enabled, it saves drive panel settings and the feedback pattern. If this selector is set to restore, when bunch cleaning is turned off these saved values will be restored.

## 5.4.6 Timing Panel

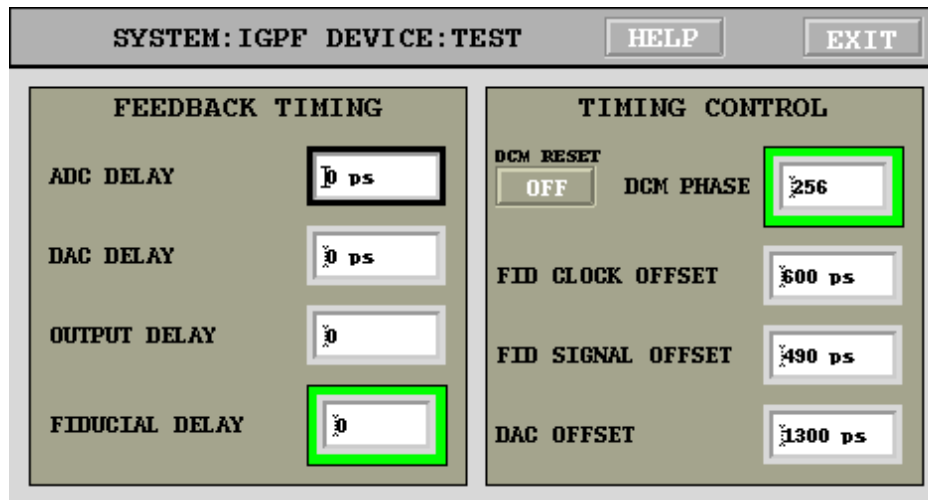

Figure 10: Timing panel

This window provides controls for system timing.

**ADC delay** High-speed ADC clock delay in picoseconds. This adjustment is independent of the back-end timing (**DAC** delay) and has a range from 0 to  $T_{rf} - 1$  ps. Rounding to 10 ps adjustment step size is handled automatically.

**DAC delay** High-speed DAC clock delay in picoseconds. This adjustment is independent of the front-end timing (**ADC** delay) and has a range from 0 to  $T_{rf} - 1$  ps. Rounding to 10 ps adjustment step size is handled automatically.

**OUTPUT DELAY** High-speed **DAC** output delay in units of **RF** periods.

**FIDUCIAL DELAY** Input fiducial delay in steps of two bunches. Use to place bunch 1 signal in channel 1 of the data acquisition. For example, if bunch 1 signal is seen in acquisition channel 3, increment this field by 1. Fiducial delay of one bunch can be achieved by adjusting *FID SIGNAL OFFSET* by one **RF** period.

**DCM RESET** Pushbutton for resetting feedback processing **DCM** (DCM1) and data acquisition **DCM** (DCM2). Push this button if *DCM unlocked*

indicators are red and the **RF** clock is present at the iGp-1281F front panel. On rare occasions due to intermittent **RF** clock loss **DCM** might need to be reset even though lock indicators are green.

**DCM PHASE ADC** data acquisition phasing. This parameter is configured at the factory and does not need to be adjusted in operation.

**FID CLOCK OFFSET** Offset between the **ADC** clock and the fiducial clock. This parameter is configured at the factory and does not need to be adjusted in operation.

**FID SIGNAL OFFSET** This offset sets the relative timing of the input fiducial signal and the fiducial receiving clock. This setting must be optimized after installation. To do so, connect the **RF** clock and the fiducial in the final (operational) configuration. Then, adjust the fiducial delay to find the error range. Let us consider, for example, **RF** frequency of 368 MHz. The **RF** period is 2700 ps. Within one period there should be a range of delays in which the fiducial is jittering across the **RF** clock and the fiducial error indicator is red. By moving the delay in steps of 100 ps find the beginning ( $N_1$ ) and the end ( $N_2$ ) of this range. The optimal setting is at  $(N_1 + N_2)/2 \pm 1350$  ps.

**DAC OFFSET** Offset between **FPGA** data and **DAC** clock. This parameter is configured at the factory and does not need to be adjusted in operation.

## 5.4.7 Drive Panel

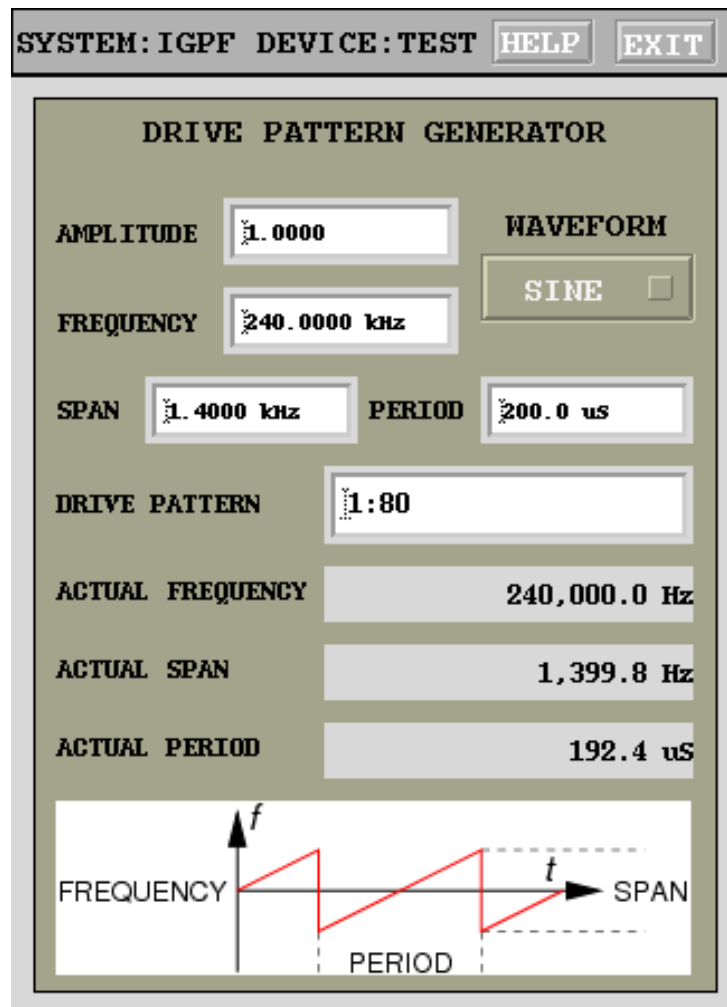

Figure 11: Drive panel

Drive panel shown in Figure 11 provides the means to generate an excitation signal on a bunch-by-bunch basis. The drive output has many applications:

- Back-end timing;
- Kicker gain checking;

- Excitation source for front-end timing;
- Bunch cleaning.

**AMPLITUDE** Drive amplitude in the range from 0 to 1.

**FREQUENCY** Drive frequency in Hz. Drive signal generator has frequency step size of  $f_{rf}/2^{30}$ .

**WAVEFORM** Waveform selector allows the user to drive the beam with sine, square, and DC signals.

**SPAN** In sine- and square-wave modes the drive generator can be frequency modulated (swept) as illustrated on the bottom of the panel. This field sets the sweep span in kHz. Setting span to 0 disables frequency modulation.

**PERIOD** This field sets the sweep period in microseconds. Setting period to 0 disables frequency modulation.

**DRIVE PATTERN** Drive pattern string selects bunches to be driven.

**ACTUAL FREQUENCY** Drive frequencies are quantized with step size  $f_{rf}/2^{30}$ . This field reads out the actual drive frequency which is the closest possible approximation to the value, specified in *FREQUENCY*.

**ACTUAL SPAN** Actual frequency span in use.

**ACTUAL PERIOD** Actual sweep period in use.

## 5.4.8 Waveforms Panel

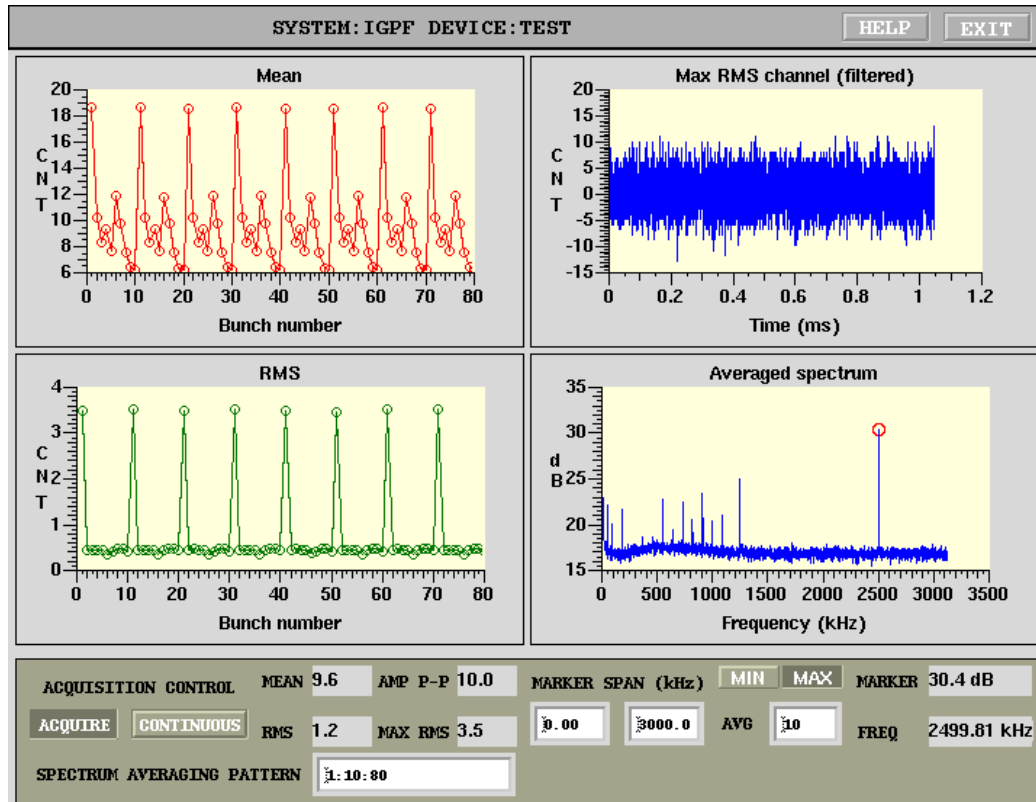

Figure 12: Waveforms panel

A set of **IOC** subroutines postprocesses the data in the real-time and provides four concise plots displayed in the waveform panel shown in Figure 12. The four plots are: bunch-by-bunch mean and root mean square (**RMS**) of bunch oscillations, time-domain signal of a bunch with the largest **RMS**. The last plot is obtained by performing the fast Fourier transform (**FFT**) on each of the bunches (specified by a selection pattern) and quadratically averaging the resulting spectra. This plot aliases all coupled-bunch eigenmodes to a frequency span from DC to  $\omega_{\text{rev}}/2$ . Such a spectrum allows the operator to very quickly check how well the system damps the coupled-bunch motion.

**DATA ACQUISITION CONTROL ON/OFF** Data acquisition enable.



Turn this control to on to acquire and postprocess the data.

**CONTINUOUS/SINGLE** Selects between single acquisition mode and continuous updates.

**MEAN** Overall mean of the data.

**RMS** Overall **RMS** of the data.

**AMP P-P** Peak-to-peak amplitude of the gap transient.

**MAX RMS** Largest **RMS** around the turn.

**SPECTRUM AVERAGING PATTERN** Bunch pattern in the format described in Sec. 5.3. This field allows the user to select a subset of bunches for quadratically averaging in the spectrum plot. Using this field one can examine single-bunch spectra or, for example, select only filled buckets to improve signal-to-noise ratio.

**MARKER RANGE** Lower and upper bounds of a frequency search range in kHz. Within this frequency range the IOC code searches the averaged spectrum and based on the search type finds maximum (peak) or minimum (notch) value and frequency.

**MIN/MAX** Spectrum search type: minimum or maximum. Maximum search is used for tracking positive peaks, e.g. in driven tune monitoring or in open loop. When the feedback loop is closed a notch typically forms in the spectrum at the tune frequency. Minimum search can then be used to provide parasitic non-invasive tune readout.

**AVG** Spectrum averaging constant. Value roughly corresponds to averaging time constant expressed in spectrum updates. For example, setting this field to 10 produces exponential time constant of 10 seconds at 1 Hz update rate. Value of 1 disables averaging.

**MARKER** Marker amplitude in dB.

**FREQ** Marker frequency in kHz.

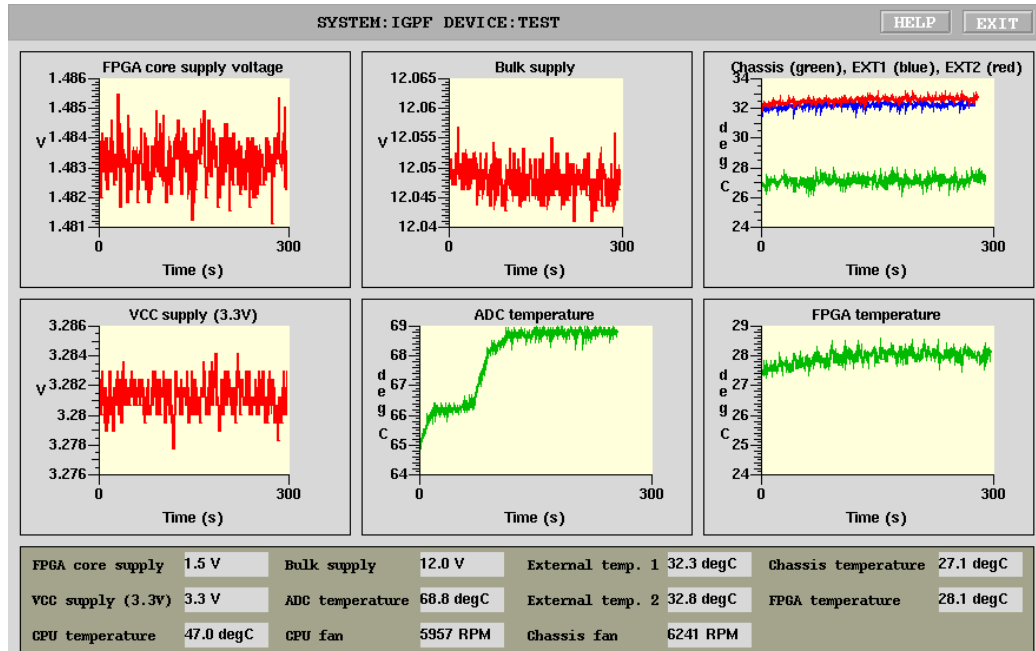

Figure 13: Environmental monitoring panel

### 5.4.9 Environmental Monitoring Panel

The environmental monitoring panel shown in Figure 13 provides instantaneous readouts and five minute histories of three supply voltages and five temperatures in the iGp-1281F system. It also monitors IOC CPU temperature and two cooling fan speeds: one mounted on the IOC CPU and the main chassis fan.

**NOTE:** *The user must check the device temperatures after the unit is installed in the final location to make sure sufficient airflow reaches the internal devices.*

**NOTE:** *Check device temperatures periodically and compare to measurements made during installation. Elevated temperatures can indicate blocked air intake filter!*

The iGp-1281F can continue operating with the main chassis fan stopped, however such operation puts high stress on certain key semiconductor devices. Prolonged operation with non-functional main chassis fan should be avoided.

## 5.4.10 Device Controls Panel

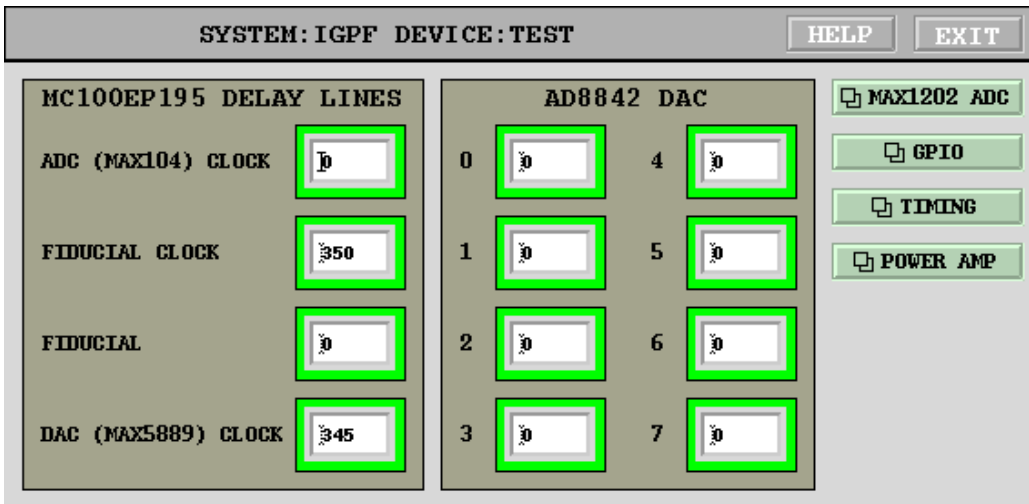

Figure 14: Device controls panel

Device controls panel provides control interface to several peripherals integrated in the iGp-1281F. There are four adjustable delay units for controlling the high-speed **ADC**, **DAC**, and fiducial timing.

**WARNING:** While these delay controls can be used to adjust various clock timings, one is strongly advised to perform the adjustments via the timing panel. Timing panel controls interface to a sophisticated IOC routine which in turn computes the necessary settings of the four delay units.

In addition to delay devices this panel provides controls for the low-speed eight channel **DAC**. Channels 0 through 6 are brought out on the front-panel connector. Channel 7 is used to trim the output offset of the high-speed **DAC**. That setting is preconfigured at the factory and should not be changed.

From the device control panel one can open four other panels: MAX1202 ADC (section 5.4.11), GPIO (section 5.4.12), TIMING (section 5.4.6), and POWER AMP (section 5.5).

### 5.4.11 8-channel ADC Panel

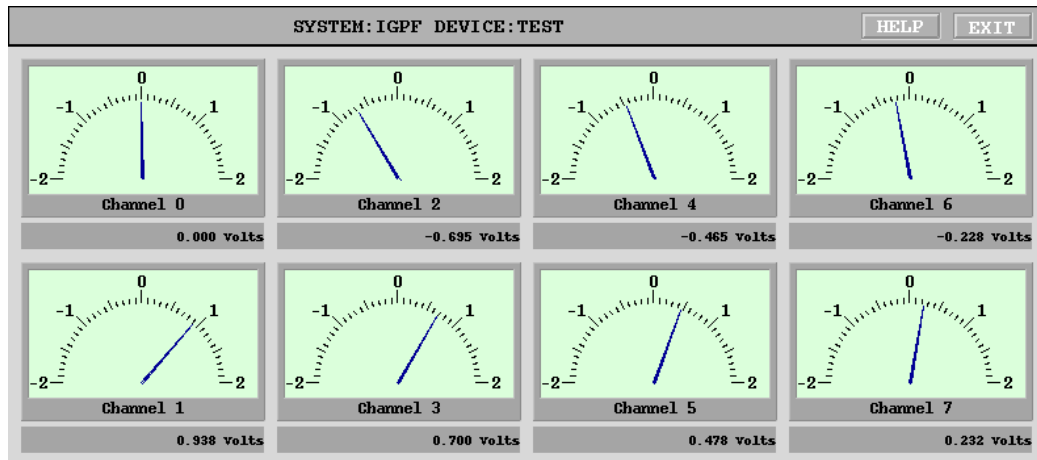

Figure 15: 8-channel ADC panel

This panel provides readouts of the eight 12-bit **ADC** channels updated at 1 Hz. The input signals are low-pass filtered to 1 kHz before sampling.

### 5.4.12 GPIO Panels

General-purpose **I/O** control panel in practice consists of two different panels, one for bit-by-bit GPIO driver and one for the front/back-end driver. Using the choice buttons on the top of the panel one can select one of the two drivers.

**WARNING: Front/back-end driver sets several **I/O** pins as outputs. Make sure correct hardware is connected to the GPIO port before selecting this driver! Improper driver selection may cause damage to the output pins and the connected external devices.**

Bit-by-bit control panel, shown in Figure 16 provides individual bit controls for 32 **LVTTL** signals available on the rear panel. Each bit control includes output value (0 or 1), direction (In or Out), and the readback. When the signal is configured for output the readback should reflect the output value.

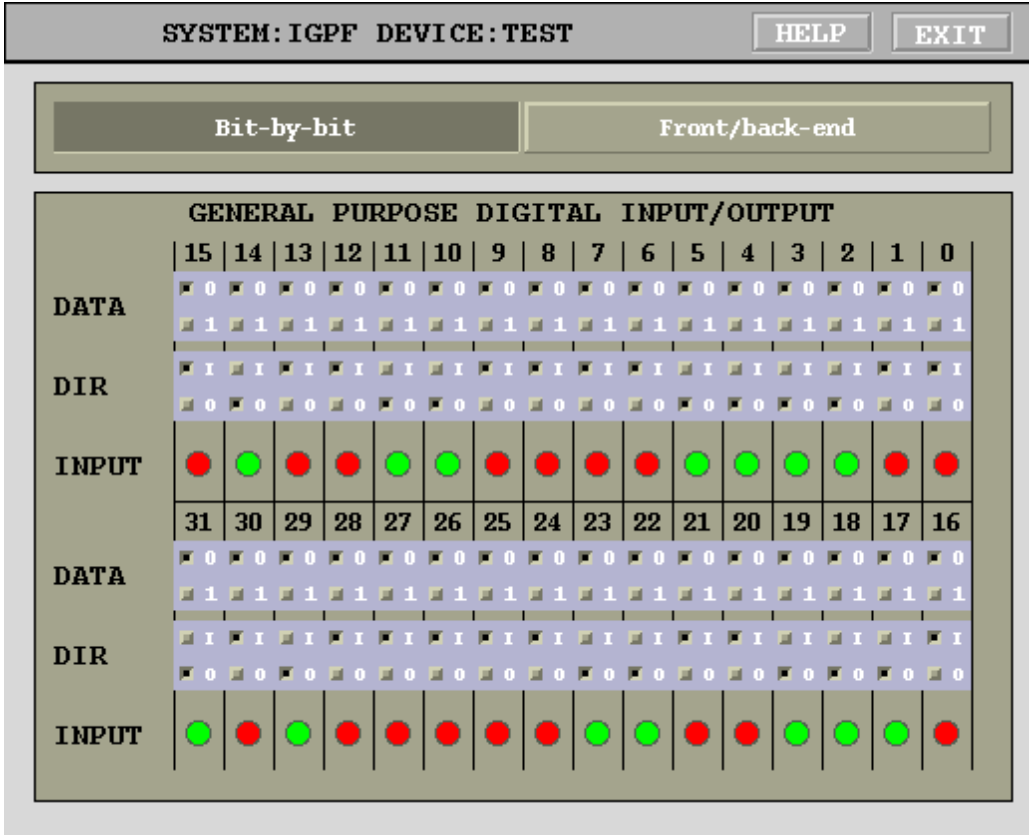

Figure 16: General-purpose I/O panel: bit-by-bit driver

Figure 17 shows the front/back-end panel. This panel is split into two portions: front/back-end registers and the phase servo loop. The register controls include front and back-end phase and attenuation. Front-end phase register setting is provided as a readout labeled FRONT-END PHASE DAC SETTING. When the phase servo loop is open the register is directly driven by the front-end phase control setpoint. Closed phase servo loop adjusts the register value around the setpoint to center the ADC signal. Front and back-end attenuation settings adjust digital attenuators in steps of 0.5 dB. Control values are in dB and are rounded automatically. Full adjustment range is from 0 to 31.5 dB.

Phase servo loop can be closed and opened by the LOOP CLOSURE

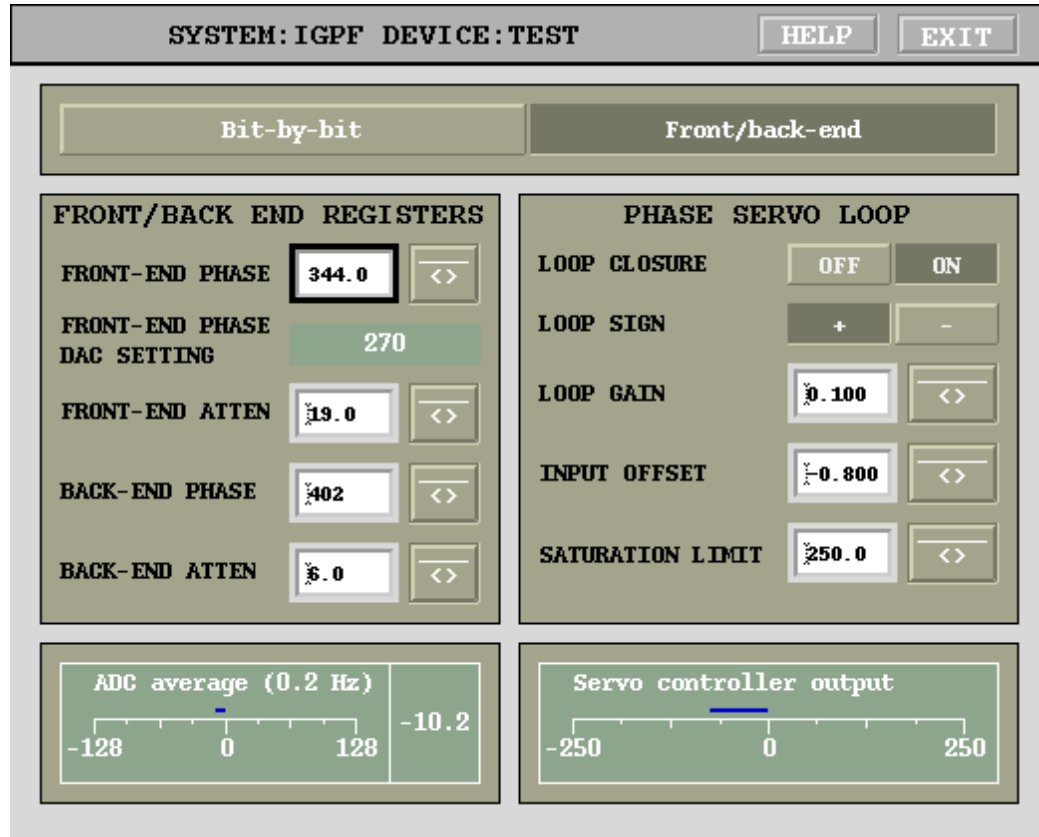

Figure 17: General-purpose I/O panel: front/back-end driver

buttons. Depending on which zero crossing the phase shifter is centered different loop polarities need to be selected using LOOP SIGN. LOOP GAIN parameter must be adjusted to optimize the loop response in terms of noise, bandwidth, and overshoot. Typically the optimization can be carried out with beam by stepping the input offset and observing the phase servo response using a stripchart tool. INPUT OFFSET is used to zero out possible mixer offset or, alternatively, to introduce an offset. Such an offset is typically used when the beam loading transient is highly asymmetric to avoid reaching ADC saturation prematurely. SATURATION LIMIT parameter defines the maximum deviation from the phase setpoint that can be introduced by the phase servo. This limit must be set below  $\pi/2$  to make sure the phase servo

does not transition from one zero crossing to another.

Readouts on the bottom provide information on the **ADC** input offset and the phase servo output. The bar indicator and the readout on the left show the output of a Cascaded Integrator Comb (**CIC**) decimator which averages  $10^9$  input samples (0.22 Hz  $-3$  dB bandwidth). The indicator on the right shows the phase servo correction applied to the setpoint. This indication can be used to adjust the setpoint for near-zero correction. Such near-zero correction is optimal for closed/open phase servo loop transitions and for low beam current operation.

## 5.5 Power Amplifier Panel

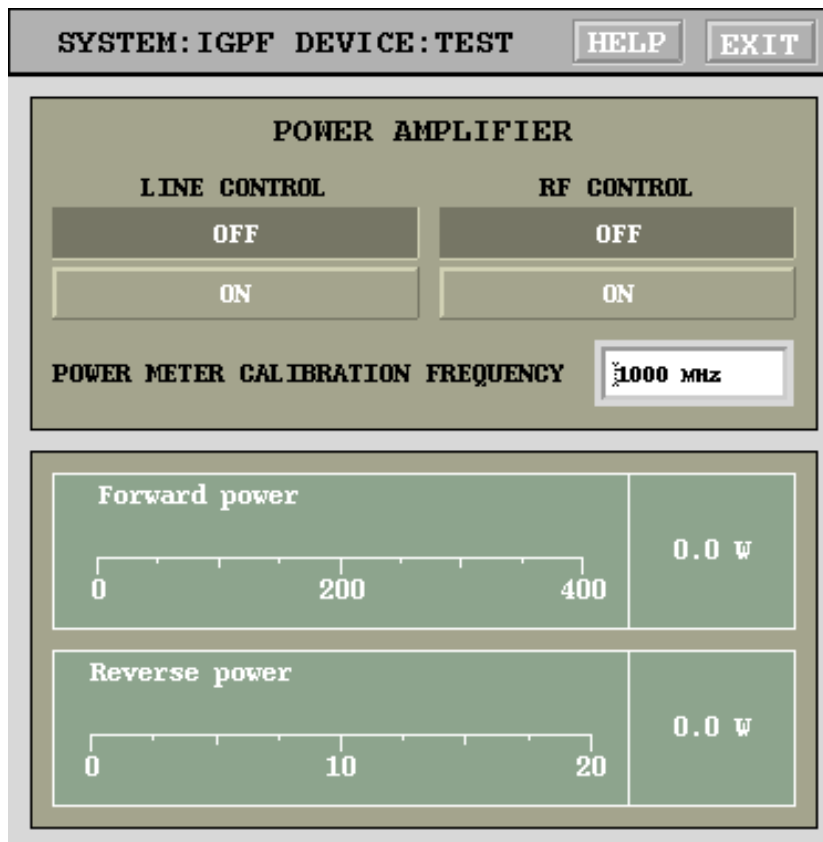

Figure 18: Power amplifier control and monitoring panel

iGp-1281F **IOC** includes driver support for Milmega power amplifier,



model AS0102-200. **IOC** can communicate with the amplifier via **USB** or RS-232 serial port. Control and monitoring functions are combined on the power amplifier panel shown in Fig. 18. Two control functions are available: line and **RF**. Line power switch turns main power supply on and off. That also controls the state of the cooling fans. **RF** control enables actual amplifier operation. Both controls will show inconsistencies between **EPICS** setting and amplifier readback in magenta. Two power meter readings are monitored at 1 Hz: forward and reverse power. Internally, Milmega amp lifers store calibration tables for these power monitors. POWER METER CALIBRATION FREQUENCY setting allows the user to select calibration value appropriate for the output frequency used.

## 6 External Software Interface

Software distribution CD includes several tools extract iGp-1281F data for analysis and processing in external software programs. These tools are written for MATLAB® and use **LabCA package** for communicating with **EPICS**.

**iGp\_read** Top-level data acquisition tool. This script will read out data from the iGp-1281F, create a timestamped directory, and save the data in a file called **gd.mat**. This file is in a format, compatible with MATLAB® data analysis tools, developed for ALS/LNF-INFN/SLAC longitudinal feedback systems.

**get\_data** This function reads out the raw data vector from the **IOC** and returns it to the caller. A single argument is the **PV** root name, e.g. **IGPF:TEST:**.

**adctest** This function extracts the iGp-1281F data and fits a sinewave to it. It accepts the **IOC** device name and the number of times to repeat the acquisition/fitting cycle.



## 7 Specifications

**Table 2: General specifications**

Parameter	Definition
Operating frequency	500 MHz
<b>RF</b> input level	-9 to 3 dBm, -3 dBm nominal
Number of <b>FIR</b> taps	16
Harmonic number	1281
Fiducial signal	Falling edge trigger, <b>NIM</b> level
Minimum fiducial pulse width	2.0 ns
External trigger inputs	2 inputs, <b>NIM</b> level, falling edge
Minimum trigger pulse width	4.0 ns
Data acquisition memory (SRAM)	8 Msamples
<b>FPGA</b> dual-port memory (blockRAM)	128 ksamples
Slow analog inputs	8 channels @12 bits, -2.048 to 2.048 V
Slow analog outputs	7 channels @8 bits, -1 to 1 V swing into 50 $\Omega$
General purpose digital I/O	32 bits in/out, <b>LVTTL</b>

**Table 3: High-speed ADC and DAC specifications**

Parameter	Definition
ADC inputs	2 complementary
ADC input full scale sensitivity	200 mV peak-to-peak (−10 dBm)
ADC resolution	8 bits
ADC input bandwidth	1.26 GHz
DAC outputs	2 complementary
DAC FS	500 mV peak-to-peak (−2 dBm)
DAC resolution	12 bits
DAC rise time (10%-90% FS)	under 250 ps
DAC fall time (90%-10% FS)	under 350 ps

**Table 4: FIR filter control**

Parameter	Definition
Coefficients	16 bit wide in Q15 format
Coefficient sets	2
Coefficient set select	0 or 1
FIR channel enable control	On/Off
Shift gain	0 to 7
Downsampling	1 to 32

**Table 5: Control parameters**

Parameter	Definition
One-turn delay adjustment	$T_{RF}$ per step, up to one revolution
DCM reset	Control panel pushbutton
DCM phase	−180 to 180 degrees in 256 steps
Clock and fiducial delays	4 channels
Clock and fiducial delay step	10 ps
Clock and fiducial delay range	0–10.23 ns
General-purpose analog outputs	7 channels
High-speed DAC offset adjustment	1 channel
General-purpose digital outputs	32 inputs/outputs

**Table 6: Data acquisition controls**

Parameter	Definition
Recording memory selection	FPGA internal blockRAM or external SRAM
Measurement trigger	Internal or external
External trigger arming	Single or after every beam data read-out
Recorded growth length	Adjustable in units of 4 samples, up to full memory length
Hold-off before recording	In units of 4 samples, 0 to $2^{32} - 1$
Recording downsampling	1 to 32

**Table 7: Monitoring and diagnostics**

Parameter	Definition
Clock status	RF clock missing, DCM lock
Feedback channel status	FIR saturation
Acquisition state machine status	Trigger arming bit
Voltages	FPGA core supply, 3.3 V, 12 V bulk
Temperatures	Fast ADC, FPGA, ambient, two emitter coupled logic (ECL) devices, IOC CPU
Fan speeds	Chassis and CPU IOC
Analog inputs	8 slow ADC channels
Digital inputs	32 general-purpose inputs/outputs

**Table 8: Drive pattern generator**

Parameter	Definition
Output waveform	Sine, square, or DC
Amplitude	0–1
Bunch selectability	Bunch-by-bunch drive enable mask. Allows any subset of bunches to be driven
Frequency range	$0 - F_{\text{rf}}/2$
Frequency quantization step	$F_{\text{rf}}/2^{30}$
Output modulation	Sawtooth frequency modulation

**Table 9: Input Power Requirements**

Parameter	Definition
Input voltage	115/230 VAC
Input current	2/1 A
Frequency	60/50 Hz
Voltage selection	Switch
Low voltage range	104–126 V
High voltage range	207–253 V

## 8 Warranty and Support

### 8.1 Warranty

Dimtel Inc. warrants this product for a period of one year from the date of shipment against defective workmanship or materials. This warranty excludes any defects, failures or damage caused by improper use or inadequate maintenance, installation or repair performed by Customer or a third party not authorized by Dimtel, Inc. Warrantied goods will be either repaired or replaced at the discretion of Dimtel, Inc. The above warranties are exclusive and no other warranty, whether written or oral, is expressed or implied.

### 8.2 Support

Dimtel Inc. will provide technical support for the product free of charge for a period of one year from the date of shipment. Such support is defined to include:

- FPGA gateway bug fixes and upgrades;
- IOC software bug fixes and upgrades;
- Client software (display panels, external interface) bug fixes and upgrades;
- Phone, e-mail, and remote access (when allowed by the Customer) support of software and hardware integration.

Free of charge technical support specifically excludes:

- Commissioning with beam;
- Feedback algorithm development and testing;
- Beam dynamics characterization;
- Operational support related to dynamic system operation.

## 9 Appendix A: Address Map

### 9.1 Registers

#### 9.1.1 Overall Layout

The general register layout for the iGp-1281F reserves space below 0x100 for **FIR** coefficients. This allows for a maximum of 128 coefficients in two sets. Control and status registers are placed starting at 0x100.

Table 10: **FPGA** registers: **FIR**

Address	Bits	Definition
0x000000	15:0	<b>FIR</b> coefficient 0, set 0
0x000001	15:0	<b>FIR</b> coefficient 0, set 1
0x000002	15:0	<b>FIR</b> coefficient 1, set 0
0x000003	15:0	<b>FIR</b> coefficient 1, set 1
0x000004	15:0	<b>FIR</b> coefficient 2, set 0
0x000005	15:0	<b>FIR</b> coefficient 2, set 1
0x000006	15:0	<b>FIR</b> coefficient 3, set 0
0x000007	15:0	<b>FIR</b> coefficient 3, set 1
0x000008	15:0	<b>FIR</b> coefficient 4, set 0
0x000009	15:0	<b>FIR</b> coefficient 4, set 1
0x00000a	15:0	<b>FIR</b> coefficient 5, set 0
0x00000b	15:0	<b>FIR</b> coefficient 5, set 1
0x00000c	15:0	<b>FIR</b> coefficient 6, set 0
0x00000d	15:0	<b>FIR</b> coefficient 6, set 1
0x00000e	15:0	<b>FIR</b> coefficient 7, set 0
0x00000f	15:0	<b>FIR</b> coefficient 7, set 1
0x000010	15:0	<b>FIR</b> coefficient 8, set 0
0x000011	15:0	<b>FIR</b> coefficient 8, set 1
0x000012	15:0	<b>FIR</b> coefficient 9, set 0
0x000013	15:0	<b>FIR</b> coefficient 9, set 1
0x000014	15:0	<b>FIR</b> coefficient 10, set 0
0x000015	15:0	<b>FIR</b> coefficient 10, set 1
0x000016	15:0	<b>FIR</b> coefficient 11, set 0
0x000017	15:0	<b>FIR</b> coefficient 11, set 1

Continued on next page

Table 10 – continued from previous page

Address	Bits	Definition
0x000018	15:0	<b>FIR</b> coefficient 12, set 0
0x000019	15:0	<b>FIR</b> coefficient 12, set 1
0x00001a	15:0	<b>FIR</b> coefficient 13, set 0
0x00001b	15:0	<b>FIR</b> coefficient 13, set 1
0x00001c	15:0	<b>FIR</b> coefficient 14, set 0
0x00001d	15:0	<b>FIR</b> coefficient 14, set 1
0x00001e	15:0	<b>FIR</b> coefficient 15, set 0
0x00001f	15:0	<b>FIR</b> coefficient 15, set 1

### 9.1.2 Gateware Config Register

Gateware config register (0x107) provides information about the unit's functionality, gateware revision, harmonic number, and processing demultiplexing.

 Table 11: **FPGA** registers: control and status

Address	Bits	Definition
		Main control register
0x000100	0	Data acquisition trigger
	1	Reserved
	2	Coefficient set select, 0 - set 0, 1 - set 1
	3	<b>FIR</b> channel disable, 1 - disabled
	6:4	Shift gain, 0 through 7
	7	<b>DCM</b> reset
	8	Grow/damp enable
	9	Trigger select, 1 - external
	10	External trigger arming, arms on rising edge
	11	<b>SRAM</b> interface select, 0 - local bus, 1 - <b>ADC</b>
	12	<b>ADC</b> test pattern generator enable <sup>1</sup>
	Continued on next page	

<sup>1</sup>Gateware revision 1.2 and higher

Table 11 – continued from previous page

Address	Bits	Definition
	13	<b>DAC</b> drive phase: 0 - 0 degrees, 1 - 180 degrees <sup>2</sup>
	14	Turn-by-turn mode of the arbitrary waveform generator <sup>2</sup>
	15	Arbitrary waveform generator enable <sup>2</sup>
	16	GPIO driver select, 0 - bit-by-bit, 1 - FBE <sup>3</sup>
	31-17	Reserved
	Status register, reset on read	
0x000101	0	<b>RF</b> clock missing
	1	Saturation
	2	Processing <b>DCM</b> unlocked
	3	External trigger arming status
	4	Local bus clock <b>DCM</b> unlocked
	5	Fiducial error
	6	Acquisition <b>DCM</b> unlocked
	31:7	Reserved
	DCM phase shift register	
0x000102	8:0	Phase shift, default 0x100 (0 deg), range 0x80(- $\pi$ ) to 0x180 ( $\pi$ )
	31:9	Unused, read out as 0
	Output delay length	
0x000104	9:0	Delay length in units of 4 samples
	10	Reserved
	15:11	Recording downsampling, 0 - every turn, $N_{ds} = \text{regval} + 1$
	20:16	Processing downsampling
	26:24	Fine delay adjustment, one sample per step
	31:27	Reserved
	Grow/damp filter 2 length	
0x000105	20:0	Number of samples to hold <i>setsel</i> inverted during data acquisition (growth length)
	31:21	Reserved
Continued on next page		

<sup>2</sup>Gateware revision 1.3 and higher

<sup>3</sup>Gateware revision 1.4 and higher



Table 11 – continued from previous page

Address	Bits	Definition
0x000106	Hold-off length	
	31:0	Number of samples to hold <i>setsel</i> inverted before data acquisition
0x000107	Gateway config register (read-only)	
	12:0	Harmonic number
	14:13	Demux mode, 0 - by4, 1 - by6, 2 - by8, 3 - reserved
	15	Reserved
	23:16	Gateway revision
0x000108	Fiducial delay	
	11:0	Fiducial delay, two samples per step
	31:12	Reserved
0x000109	Acquisition length	
	20:0	Acquisition length in units of 4 samples
	31:21	Reserved
0x000200	Acquisition status (read-only)	
	0	Acquisition in progress, memory busy
	31:2	Reserved
0x000201	ADC test counter start <sup>4</sup>	
	31:0	Test pattern start value
0x000202	CIC mean output (read-only) <sup>5</sup>	
	31:0	Decimated input average, direct current (DC) gain of $15.625 \times 10^6$

## 9.2 Drive pattern memory

An arbitrary waveform generator with bunch-by-bunch masking is integrated in the **FPGA** gateway. The generator uses two memory blocks to define the waveform and the bunch mask as documented in Table 12.

<sup>4</sup>Gateway revision 1.2 and higher

<sup>5</sup>Gateway revision 1.4 and higher

**Table 12: Drive pattern memory**

Address	Bits	Definition
0x040000–0x45fff	8:0	Drive pattern memory, even samples
0x040000–0x45fff	20:12	Drive pattern memory, odd samples
0x048000–0x487ff	3:0	Bunch mask memory, bit 0 - first bunch, bit 1 - last

### 9.3 Environmental monitor

iGp-1281F uses two MAX1299 devices for monitoring five temperatures and three power supply voltages. The SPI interface module for the controller uses sixteen addresses, as described in table 13.

Let's consider the first device (addresses 0x110–0x117). Analog inputs 0 and 1 (AIN0, AIN1) are connected to the FPGA temperature diode. General conversion function from the raw register value to temperature in degrees Celsius is  $x/32 - 273.15$ . Analog inputs 2 and 3 are used to measure the temperature of the MAX104 ADC. The ADC provides two current sources  $I_{ptat}$  and  $I_{pconst}$  for temperature measurement. ADC temperature is given by  $300I_{ptat}/I_{pconst} - 273$ . In the iGp-1281F the two sources are loaded by 5.1 k $\Omega$  resistors and connected to AIN2 and AIN3.

MAX1299 also measures the ambient chassis temperature via the internal diode. Two supply voltages are measured: FPGA core (1.5 V) connected to AIN4 and 3.3 V supply internally measured by MAX1299. Raw register value can be converted to voltage by  $2.4 \times X/16384$ . For the 3.3 V supply the value must be multiplied by 4, since MAX1299 monitors  $V_{dd}/4$ .

The second device is configured for external temperature sensors at AIN0–AIN1 and AIN2–AIN3. AIN4 is connected to a resistive divider monitoring bulk 12 V supply. Divider ratio is 1/6 for 2 V nominal ADC input.

**Table 13: FPGA registers: MAX1299 monitors**

Address	Bits	Definition
0x000110	15:0	Device 1, AIN2 ( $V_{ptat}$ )
0x000111	15:0	Device 1, AIN3 ( $V_{pconst}$ )
0x000112	15:0	Device 1, AIN4, FPGA core voltage $V_{int}$
Continued on next page		

**Table 13 – continued from previous page**

Address	Bits	Definition
0x000113	15:0	Device 1, Internal diode
0x000114	15:0	Device 1, $V_{dd}/4$ , 3.3 V supply monitor
0x000115	15:0	Device 1, External diode (AIN0/AIN1), FPGA die temperature
0x000116	15:0	Device 1, AIN2-AIN3 differential measurement
0x000117	15:0	Device 1, AIN5-AIN5 differential measurement
0x000118	15:0	Device 2, AIN2
0x000119	15:0	Device 2, AIN3
0x00011a	15:0	Device 2, AIN4, bulk supply monitor
0x00011b	15:0	Device 2, Internal diode
0x00011c	15:0	Device 2, $V_{dd}/4$ , 3.3 V supply monitor
0x00011d	15:0	Device 2, External diode (AIN0/AIN1)
0x00011e	15:0	Device 2, External diode (AIN2/AIN3)
0x00011f	15:0	Device 2, AIN5-AIN5 differential measurement

## 9.4 MAX1202 8-channel ADC

iGp-1281F includes 8-channel 12-bit serial-interface **ADC**. The SPI controller for the **ADC** uses 8 consecutive addresses, as shown in Table 14. **ADC** is continuously polled by the controller. Reading one of the channel registers returns the result of the last conversion. **ADC** data is sign extended from 12 bits to 16. The valid data range is from 0xf800 to 0x7ff. **ADC** input range is from  $-2.048$  to  $2.047$  V, i.e. 1 mV per LSB.

 Table 14: **FPGA** registers: MAX1202 **ADC**

Address	Bits	Definition
0x000120	11:0	<b>ADC</b> channel 0
0x000121	11:0	<b>ADC</b> channel 1
0x000122	11:0	<b>ADC</b> channel 2
0x000123	11:0	<b>ADC</b> channel 3
0x000124	11:0	<b>ADC</b> channel 4
Continued on next page		

Table 14 – continued from previous page

Address	Bits	Definition
0x000125	11:0	DAC channel 5
0x000126	11:0	DAC channel 6
0x000127	11:0	DAC channel 7

## 9.5 AD8842 8-channel DAC

iGp-1281F includes 8-channel 8-bit serial-interface DAC. The SPI controller for the DAC uses 8 consecutive addresses, as shown in Table 15. Writing to one of the registers starts an SPI writing cycle which loads the new value into the DAC. On writes only the 8 LSB are used. Register reads are sign-extended to 16 bits. DAC reference voltage is 3 V for  $-3$  to  $+3$  V output range. Output drivers generate full swing into high-impedance loads. For  $50\ \Omega$  loads the swing is reduced to 1 V.

Unlike other DAC channels, channel 7 is not brought out to the front-panel connector. Its output is used to trim the DC level of the high-speed DAC. The output is attenuated to produce  $\pm 5\%$  of full-scale adjustment of the DC level.

Table 15: FPGA registers: AD8842 DAC

Address	Bits	Definition
0x000128	7:0	DAC channel 0
0x000129	7:0	DAC channel 1
0x00012a	7:0	DAC channel 2
0x00012b	7:0	DAC channel 3
0x00012c	7:0	DAC channel 4
0x00012d	7:0	DAC channel 5
0x00012e	7:0	DAC channel 6
0x00012f	7:0	DAC channel 7

## 9.6 ECL delay lines

Several MC100EP195 **ECL** delay lines are used on the iGp-1281F to line up the received RF clock and the fiducial signal. These lines are controlled by registers described in Table 16.

Delay line 0 controls the delay of the **ADC** clock. Relative delay between lines 1 and 2 is used to achieve reliable detection of the fiducial falling edge in the front-end. Once that relative delay is determined, both 1 and 2 must be adjusted together to achieve proper timing between the fiducial (reset) pulse to the **ADC** and the **ADC** clock. This second stage fixes relative delays between 0, 1, and 2. Finally, delay line 3 must be adjusted to achieve optimal placement of the **DAC** clock relative to the FPGA data.

Table 16: **FPGA** registers: **ECL** delay lines

Address	Bits	Definition
0x000130	9:0	Delay line 0 ( <b>ADC</b> clock)
0x000131	9:0	Delay line 1 (Fiducial clock)
0x000132	9:0	Delay line 2 (Fiducial)
0x000133	9:0	Delay line 3 ( <b>DAC</b> clock)

## 9.7 General-purpose digital I/O

There are two distinctly different drivers implemented in the gateway for the control of the general-purpose digital **I/O** port of the iGp-1281F. A generic bit-by-bit driver is accessed when bit 16 of the main control register (0x100) is set to 0. The port is accessed via three registers listed in Table 17.

Table 17: **FPGA** registers: bit-by-bit GPIO

Address	Bits	Definition
0x000138	31:0	Output data
0x000139	31:0	Direction (1 - out, 0 - in)
0x00013a	31:0	Pin value readback

A custom driver designed for interfacing to Dimtel, Inc. longitudinal front/back-end units (FBE) is selected when bit 16 of the main control register is set to 1. The custom driver is included in the gateway starting from version 1.4. Front and back-end phase settings control carrier phases in the front and the back-end respectively. Offset-binary DAC setting in each case provides adjustment range of  $\approx 400$  degrees at the carrier frequency. Front and back-end attenuation settings are in 0.5 dB steps for a total range of 31.5 dB.

 Table 18: **FPGA** registers: Front/back-end GPIO

Address	Bits	Definition
0x00013c	11:0	Front-end phase
0x00013d	11:0	Back-end phase
0x00013e	5:0	Front-end attenuation
0x00013f	5:0	Back-end attenuation

## 9.8 Memory

iGp-1281F is configured with two data acquisition memory spaces: **blockRAM** internal to the **FPGA** and external **SRAM**. Memory address mapping is provided in Table 19.

Table 19: Data acquisition memory

Address range	Definition
0x010000-0x017fff	32k×32 <b>blockRAM</b> (128 ksamples)
0x800000-0xa00000	2M×32 <b>SRAM</b> (8 Msamples)

## 10 Appendix B: Connector Pinouts

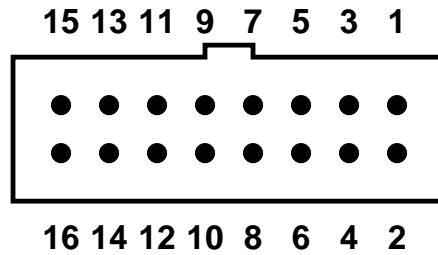

Figure 19: Pin numbering for 16-pin header-type front-panel connectors

Pin numbering scheme for the 16-pin front-panel connectors is shown in Figure 19. Pin definitions for the 7-channel DAC are given in Table 20 and for the 8-channel DAC - in Table 21.

Table 20: 7-channel DAC pinout

Pin number	Definition
1	Channel 0
2	GND
3	Channel 1
4	GND
5	Channel 2
6	GND
7	Channel 3
8	GND
9	Channel 4
10	GND
11	Channel 5
12	GND
13	Channel 6
14	GND
15	N/C
16	GND

Table 21: 8-channel ADC pinout

Pin number	Definition
1	Channel 7
2	GND
3	Channel 6
4	GND
5	Channel 5
6	GND
7	Channel 4
8	GND
9	Channel 3
10	GND
11	Channel 2
12	GND
13	Channel 1
14	GND
15	Channel 0
16	GND

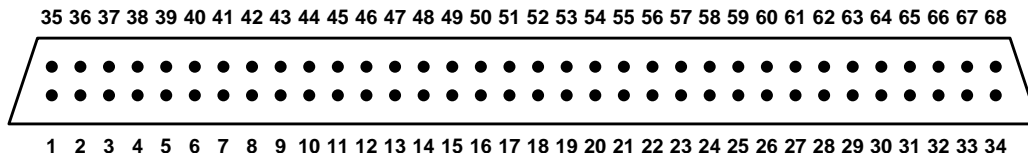

Figure 20: Pin numbering for general-purpose digital I/O connector

Figure 20 shows the pin numbering for the general-purpose digital I/O connector. Pin definitions are listed in Table 22.



Table 22: General-purpose digital I/O pinout

Pin number	Definition
1	Bit 31
2	Bit 30
3	Bit 29
4	Bit 28
5	Bit 27
6	Bit 26
7	Bit 25
8	Bit 24
9	Bit 23
10	Bit 22
11	Bit 21
12	Bit 20
13	Bit 19
14	Bit 18
15	Bit 17
16	Bit 16
17	GND
18	Bit 15
19	Bit 14
20	Bit 13
21	Bit 12
22	Bit 11
23	Bit 10
24	Bit 9
25	Bit 8
26	Bit 7
27	Bit 6
28	Bit 5
29	Bit 4
30	Bit 3
31	Bit 2
32	Bit 1
33	Bit 0

Continued on next page

Table 22 – continued from previous page

Pin number	Definition
34	Bit N/C
35	GND
36	GND
37	GND
38	GND
39	GND
40	GND
41	GND
42	GND
43	GND
44	GND
45	GND
46	GND
47	GND
48	GND
49	GND
50	GND
51	GND
52	GND
53	GND
54	GND
55	GND
56	GND
57	GND
58	GND
59	GND
60	GND
61	GND
62	GND
63	GND
64	GND
65	GND
66	GND
67	GND
68	N/C



## 11 Glossary

### Glossary

#### **analog-to-digital converter (ADC)**

An electronic circuit that converts continuous analog signals to discrete digital numbers. [5](#), [6](#), [9](#), [13](#), [15](#), [26](#), [27](#), [33-35](#), [37](#), [39](#), [45](#), [46](#), [48](#), [49](#), [51](#)

#### **blockRAM**

Random access memory integrated in Xilinx<sup>®</sup> FPGA in a form of multiple 18 kbit blocks. [15](#), [20](#), [39](#), [52](#)

#### **Cascaded Integrator Comb (CIC)**

A discrete-time filter, which efficiently averages a large number of input samples. Such filters are typically used for sampling rate changes (decimation and interpolation). [37](#), [46](#)

#### **digital-to-analog converter (DAC)**

A hardware device to convert a sequence of digital codes to corresponding analog voltages or currents. [4-7](#), [9](#), [13](#), [15](#), [18](#), [26](#), [27](#), [33](#), [39](#), [45](#), [50](#), [51](#), [53](#), [59](#)

#### **direct current (DC)**

In electrical engineering context — a constant signal, either voltage or current. [46](#)

#### **digital clock manager (DCM)**

A delay-locked loop ([DLL](#)) based clock management circuit integrated in the Xilinx<sup>®</sup> FPGA. The circuit allows fine phase adjustment of the output clock relative to the input. [7](#), [15](#), [21](#), [26](#), [39](#), [45](#)

#### **delay-locked loop (DLL)**

A device for managing clock skew in digital circuits. [58](#)

**emitter coupled logic (ECL)**

A logic device family in which current is steered through bipolar transistors to compute logical functions. The chief characteristic of ECL is that the transistors are always in the active region and can thus change state very rapidly, allowing ECL circuits to operate at very high speed. [39](#), [50](#), [51](#)

**extensible display manager (EDM)**

A tool that manages a collection of active displays with the ability to create and edit display content as well as the ability to execute the same content resulting in the dynamic presentation of live data. [15](#), [17](#)

**experimental physics and industrial control system (EPICS)**

A set of software tools and applications used to develop distributed soft real-time control systems. [6](#), [10](#), [12](#), [15](#), [16](#), [22](#), [37](#), [38](#), [60](#)

**Ethernet**

A family of frame-based computer networking technologies for local area networks. [5](#), [9](#)

**fast Fourier transform (FFT)**

An efficient algorithm to compute the discrete Fourier transform. [30](#)

**finite impulse response (FIR)**

A discrete-time filter, output of which only depends on a finite number of previous input samples. [4](#), [6](#), [18](#), [21](#), [39](#), [44](#), [45](#)

**field programmable gate array (FPGA)**

A semiconductor device containing programmable logic components and programmable interconnects. [5](#), [6](#), [12](#), [13](#), [15](#), [20](#), [27](#), [39](#), [44](#), [45](#), [47–52](#)

**full-scale (FS)**

Difference between maximum and minimum limits of the signal. For example, [DAC](#) full-scale is the difference of the outputs for maximum and minimum codes. [6](#), [9](#), [39](#)

**input/output (I/O)**

An interface for transferring analog or digital signals to or from the device. [5](#), [13](#), [15](#), [34](#), [51](#), [54](#)

**input-output controller (IOC)**

An embedded computer used to interface the hardware to the control system. [5](#), [9–13](#), [15–17](#), [21](#), [30](#), [31](#), [37](#), [38](#)

**Linux**

A Unix-like open-source operating system. [5](#)

**low-voltage transistor-transistor logic (LVTTTL)**

Transistor-transistor logic with the same logic thresholds as transistor-transistor logic ([TTL](#)). LVTTTL outputs can be connected directly to [TTL](#) inputs. [TTL](#) outputs can drive LVTTTL inputs only if the latter are 5 V tolerant. [8](#), [34](#), [39](#)

**NIM**

NIM (originally an acronym for Nuclear Instrumentation Methods) logic defines signal levels (with 50  $\Omega$  termination) of 0 V and  $-0.8$  V for logic 0 and 1 respectively. [6](#), [9](#), [20](#), [39](#)

**process variable (PV)**

An individual control or readout signal in [EPICS 12](#), [38](#)

**radio frequency (RF)**

In the accelerator context, a constant frequency constant amplitude signal derived from or phase locked to the storage ring master oscillator. [5–7](#), [9](#), [13](#), [21](#), [26](#), [27](#), [37](#), [39](#), [45](#)

**root mean square (RMS)**

A statistical measure of the magnitude of a varying quantity. [30](#), [31](#)

**static random access memory (SRAM)**

A type of semiconductor memory that retains its contents as long as the power is applied. [5](#), [15](#), [20](#), [39](#), [45](#), [52](#)

**transistor-transistor logic (TTL)**

A class of digital circuits built from bipolar junction transistors and resistors. TTL defining signal levels:  $V_{OH} = 2.4 V$ ,  $V_{OL} = 0.4 V$ ,  $V_{IH} = 2 V$ , and  $V_{IL} = 0.8 V$  [60](#)

**universal serial bus (USB)**

A serial bus standard to interface a wide variety of devices. [5](#), [37](#)